



Phoenix
Lighting Solutions



Phoenix
Lighting Solutions

EDITION 2021

About Us

Phoenix Lighting Solutions are an international suppliers of advanced lighting solutions. We've been equipping major projects for the past few years and are at the forefront of technology, full of innovative ideas to save energy, enhance sustainability, simplify installation, reduce costs and make advanced controls intuitive and accessible to all. Our core focus is to Design, Value Engineering Supply and Install a wide range of energy efficient lighting and electrical products. We are also one of the leading providers of innovative decorative lighting imported from Italy, United Kingdom, Spain, France, Germany and Greece. We have built a powerful tie-up with such international brands including, Philips, Osram, Disano, Trilux, Zumtobel, Thorn, Arcluce, Erco, Ideal Lux, Bolutec, Arkos, Lux May, fumagalli and more... It is our policy to provide at all times an irreproachable quality in our products and a unique and efficient customer service, to deliver projects on schedule and to the highest standards of workmanship thereby ensuring continuous satisfaction to our valued clients.



"Excellent quality, lighting the future"

Our Vision

At Phoenix, everything we do, every single day, is with the intention of creating and delivering products that allow people to see what matters most to them. We will do that by relentlessly pursuing ever-better quality, ensuring continued innovation, we designs and supplies sustainable lighting solutions for professional customers, enabling them to reduce costs, energy consumption and environmental impact, as we always go one step further in our commitment to exceptional customer service and education, as well as creating on-trend designs that are both stylish & "life-stylish," promising to deliver project success for you.



Our Customer

Phoenix Lighting Solutions is committed to a Customer First attitude and provide superior service in fulfilling customer needs. We resolve to provide outstanding service before and after the sale, and take pride in maintaining long term relationships with our customers. From product selection and specification through delivery and beyond, Phoenix Lighting is focused on providing the information, assistance, technical support and product when needed. Simply put, our company strives to be easy to do business with. At Phoenix our Engineering team apply their lighting experience and expertise to enhance the overall customer experience. Combining that capability with the strength of our product line and expert agency sales force, you can count on Phoenix Lighting to support you for all your lighting needs.



Our Mission

Our mission is to be the leading provider of innovative, environmentally-friendly, top-quality fixtures & related products to U.A.E and worldwide commercial, institutional and utility markets. As a recognized leader in the lighting industry it is our responsibility to deliver superior value to our customers & their clients on a consistent basis. This commitment permeates everything we do, driving us to continuously develop and improve our products & the processes necessary to fulfill today's needs for high quality, energy-efficient, eco-friendly lighting solutions. We want you to be there with us...Everyone can make a difference.

Phoenix believes that we have a responsibility to care for and protect the environment in which we operate. We are fully committed to improving environmental performance across all of our products and other business activities, continually looking for new methods and materials to provide environmentally friendly solutions without sacrificing the cost-savings enjoyed by our customers. Together we save money, reduce energy use, and shrink your carbon footprint.



LIGHTING SOLUTION APPLICATIONS



Residential

Phoenix residential luminaire selection is extremely wide and designed to cover all professional needs in general lighting at home as well as in public premises.



Public Premises

Efficient and functional lighting enhances productivity and improves performance. Phoenix public premises luminaires can be designed and installed to make the best possible lighting for each situation.



Industrial

Phoenix solves industrial lighting needs. Paper mill or parking hall; our efficient, wide and light technically superior portfolio suits almost everywhere.



Outdoor

Phoenix outdoor luminaire selection is energy efficient, long lasting and economically sustainable. We know how to light parks, squares as well as yards and parking areas.



Vertical Solar Street Light

Vertical Solar Pole LED Street Lighting System completely overturns the traditional street-lights using flat solar panels on the top, Such vertical solar led street light using solar module achieves a better aesthetic design as well as excellent performance in wind resistance.



Decorative

We know how to select fine hospitality lightings. Phoenix's expertise in choosing and stunning lightings. All we need is your ideas or drawings, we will turn it into a real lighting fixture with technology and value engineering eventually. Shade, size, color, even the materials, Phoenix's team have the skills to enhance any interior scheme by taking a client's vision.

INTERNAL DOWNLIGHT LUMINARIES

Our range of LED downlights is a real step forward in lighting your property. They are perfect if you are looking to upgrade the lighting in any room. Our downlights are selected to provide energy efficient lighting to any room you desire. efficient lighting to any room you desire.

One of the key benefits of our LED downlights is that they are long lasting. This means they will lower the overall lighting costs of your property compared to other lighting alternatives.

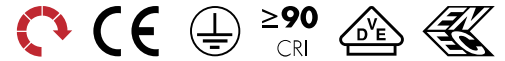

INTERNAL LINEAR LUMINARIES

Internal linear luminaire & pendant lights has been carefully put together from the ranges of a number of selected manufacturers, providers and artisans, making sure that every light is a beautiful design piece in its own right. Making use of pendant lights may be a stylish and artistic way to provide illumination without the obtrusive bulk of other light styles. They are able to fit into any style of decor, from sleek, modern and contemporary design to comfortable and cosy rustic spaces or traditional and formal rooms.

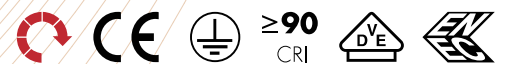

INTERNAL Highbay LUMINARIES

Our selection of waterproof High Bays are most versatile and best-selling fixture to date, we supply LED UFO high bay, Linear high bay and corn high bay, there are fully waterproof, midsize, multifunctional, energy-efficient lighting solution featuring a tough, die cast powder coated aluminum housing and manufactured with industrial grade components for a maintenance-free, long life.

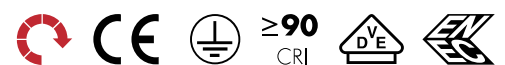

"An excellent choice for new industry premises or replacing old metal halide luminaires."

EXTERNAL POST TOP LUMINARIES

We have a wide range of post top light, LED flood lights and garden lights. When it comes to outdoor LED garden lights are one of the most efficient types of lighting you can get to add extra brightness to your external area. This is why so many people prefer them to regular forms of lighting. If you are considering illuminating the exterior of your project, we highly recommend any of our outdoor lighting range.

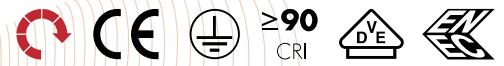

EXTERNAL STREET LUMINARIES

Phoenix Street Lights collection are the ideal solution that fulfills requirements of functional street lighting and residential areas. Efficient systems to reduce energy consumption and to create a more attractive urban living environment and visual comforts for public and residential areas. our luminaires are available with SPD Optional 10/15/20KV & Photocell NEMA socket 3 pins & 7 pins.

At Phoenix we have our own attested ADQCC certification for street light registered under Phoenix Lighting Solutions L.L.C from 45W - 240W with 10 years warranty and competitive prices.

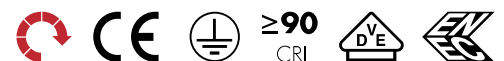

"Wide variety of shapes and colours. Classic white for most, copper takes you to next level."

VERTICAL SOLAR STREET LIGHT

Vertical Solar Pole LED Street Lighting System completely overturns the traditional street-lights using flat solar panels on the top, Such vertical solar led street light using solar module achieves a better aesthetic design as well as excellent performance in wind resistance.

Based on polygonal structure, solar panel can be easily mounted on the aluminum, HDG pole. widely lumen range is available for different project requirement.

Vertical solar LED street light pole is an great innovation with latest technology. It adopts the vertical solar modules by surrounding the pole instead of regular solar panel installed on top. Comparing with traditional solar led street light, it has a very cosmetic appearance in the same look as traditional street light.



Smart solar solutions are rapidly growing in demand across the world. In remote off-grid areas such as deserts and jungles, such systems represent the only viable solution to lighting needs. In modern cities, smart solar LED street lights are

embraced as the technology of the future that combines environmental, economical, and smart-control benefits. Regulators in Middle East, Europe, and North America are pushing for the adoption of innovative solar technologies, and will continue to do so with increasing pressure.



SOLAR MOBILE TOWER LIGHT



Solar Mobile Light tower offers a revolutionary lighting and power solutions to the remote area's needs. It's perfectly suitable for work sites and contractors project field. Highly useful for night working at remote area where electricity is not accessible. Specially made for project sites, it has a rugged design to stand the site conditions.

Technical Feature

Maximum height 7m galvanized moveable mast
2 galvanized stabilizers adjustable in height
Flood lights routable by hand at 360°
4 high efficiency LED floodlights
Structure assembled on a single axle trailer:

- No fuel needed – Just free, Renewable
- Energy from the Sun
- Environmentally friendly
- Isolated 100% maintenance free batteries
- Easy to use; on/off switch or automatic on at night
- Completely silent
- Completely adjustable flood lights
- No running cost
- Easy to store solar panels and tower can be folded



CATEC MOBILITY

Netherland

We Power Up
Electric Cars
Everywhere
They Go.

WHO WE ARE

At CATEC Mobility we provide charging solutions that are compatible with all electric vehicle brands We build easy to use and durable charging solutions for electric cars So every electric vehicle driver can hit the road fully charged, and a zero emission world becomes a reality

6 Experienced Technicians - Project Engineer
5 Years of Experience

Clients

100+

Projects

220+

Awards

30+

Experience

15+



FABRICATION LIGHTS

Everything from optics and movement detection to artificial intelligent and learning can be added to the variety of our high running portfolio.

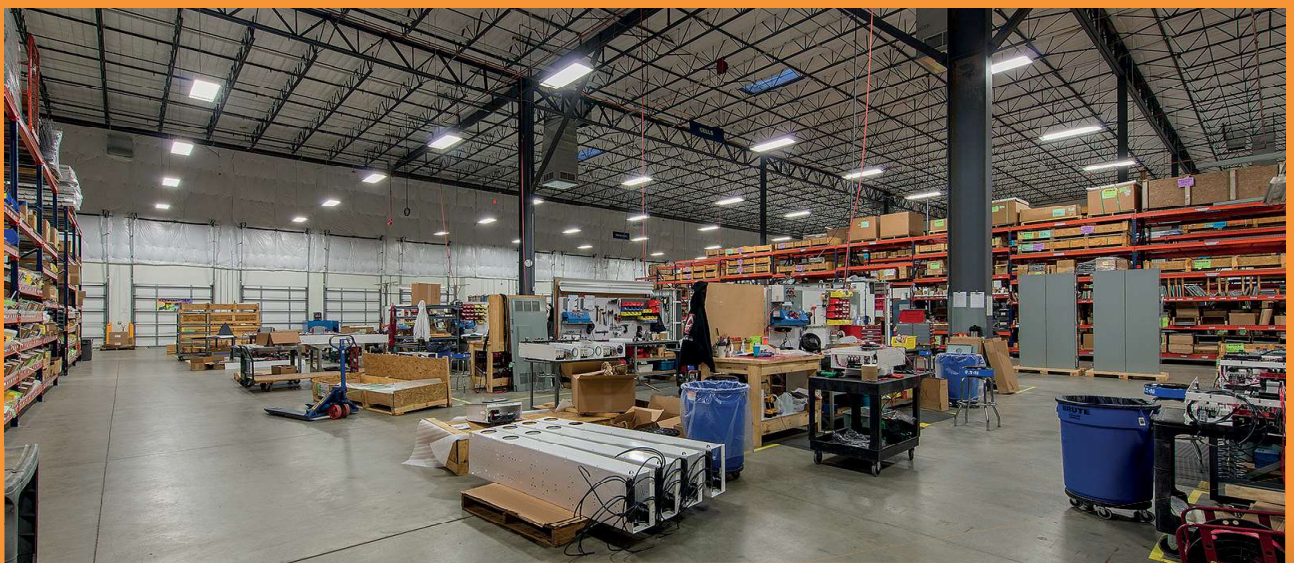

SERVICES

ENERGY SAVING SOLUTIONS

At Phoenix we are here to offer a truly sustainable and commercially viable solutions and support you to achieve together U.A.E Sustainable vision effectively by reduce your carbon footprint with our LED system & solar lights.



CONCEPTUAL AND DETAILED DESIGN

The Engineering team at Phoenix engage our clients from the very early stages with a well experienced team of lighting Engineers who can provide lighting consultations, luminous calculations, lighting distribution, From one day charrettes to conceptual presentations including preliminary sketches, typical layouts, detailed design, lux calculations, budgets & models or mock-ups of critical lighting treatments done by our well-educated Lighting Engineers.

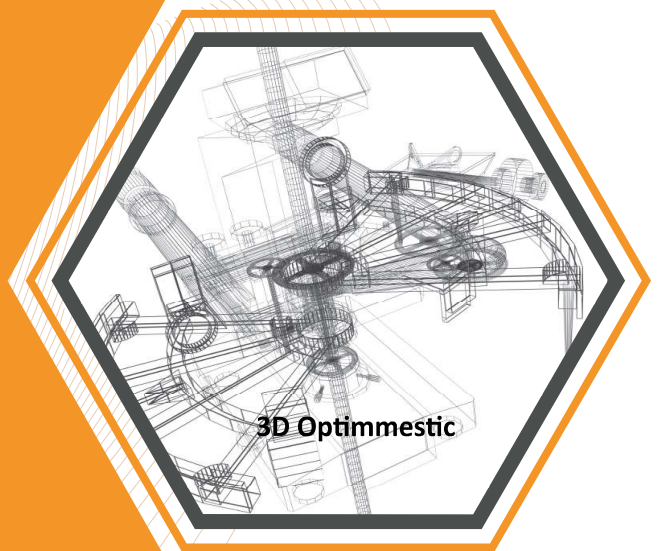

VALUE ENGINEERING

Value engineering is our playground. It is what we do every day. We have the expertise to advise you on a second opinion with the best quality. Our professional Engineers evaluate your site lighting layouts to ensure cost effectiveness. Eliminating non-essential poles and fixtures on a layout can save overall project budget. We look over the lighting schedule for any cost/performance discrepancies and help you find the right solution while saving money on the overall light package.



ASSOCIATED PARTNERS

ARKOS LIGHT®



ZUMTOBEL

p.u.k.® Italian Architectural Lighting



Mazda
LED

BOLUCE®
ILLUMINAZIONE

SYLVANIA

disano 
illuminazione



TRILUX
SIMPLIFY YOUR LIGHT.

Securlite
LA LUMIÈRE DURABLE

ARCLUCE 

OSRAM

TRIDONIC

LUCECO 

ATM 
lighting

K-LITE

BENITO

IDEAL LUX®

 **linea**
light
group

Whitecroft
lighting 

Lux-May

OUR WORK PROCESS



ADQCC CERTIFICATE

مجلس أبوظبي للجودة والمطابقة
ABU DHABI QUALITY AND CONFORMITY COUNCIL



شهادة المطابقة Certificate of Conformity

Certificate No.	QAD-2021.0182.01-ELEDL	رقم الشهادة:
This certificate is issued for the product:	STREET LIGHTS	تم منح هذه الشهادة للمنتج:
Certificate Holder:	Phoenix Lighting Solutions LLC	الخاص بشركة:
According to the requirements of:	Exterior LED Luminaires Certification Scheme	وفقا للمتطلبات الخاصة بـ:
Issued Date:	18 August 2020	تاريخ الإصدار:
Expiry Date:	17 August 2022	تاريخ انتهاء الصلاحية:



QAD-2021.0182.01-ELEDL

This is an electronic certificate and does not require stamp
Visit our website to verify this certificate:
<https://jawdah.qcc.abudhabi.ae/en/pages/homepage.aspx>
Any changes or modification on this certificate will affect its validity

هذه الشهادة صدرت إلكترونياً ولا تحتاج إلى ختم
للتأكد من صحة هذه الشهادة يرجى زيارة موقع جودة الإلكتروني:
<https://jawdah.qcc.abudhabi.ae/en/pages/homepage.aspx>
أي كتم أو تغيير في هذه الشهادة يلغيها